

# Installation Guide For Aero-Stream® Septic Tank Riser Kits

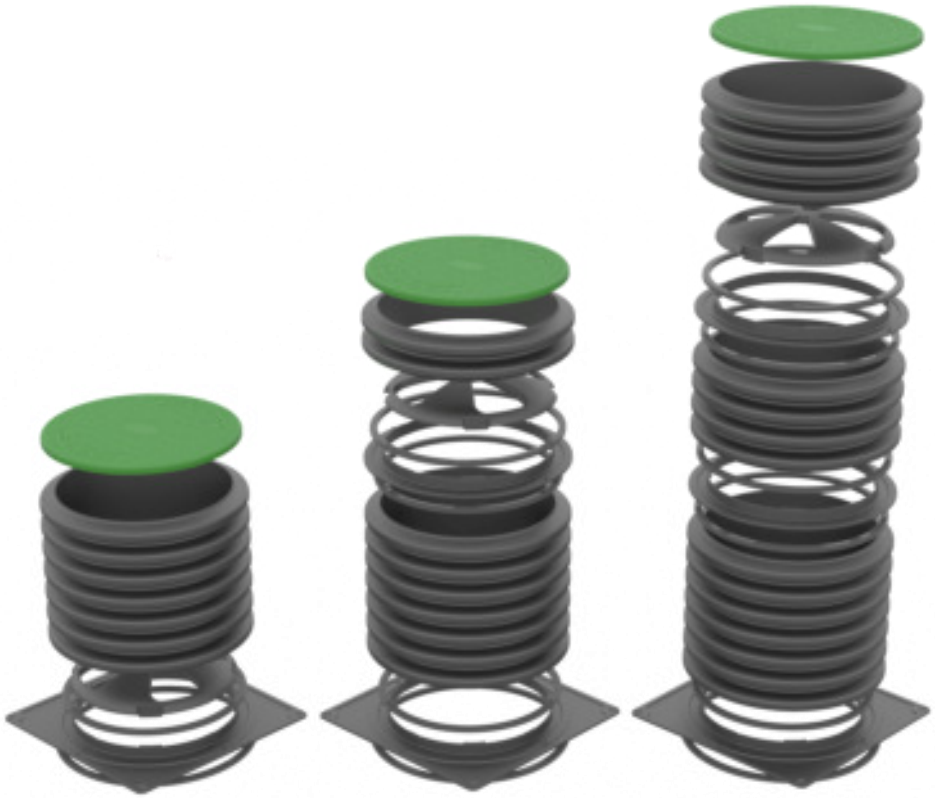

**For additional assistance please contact us at:**

**Technical Support**

(Toll Free) 877-254-7093

OR

[info@aero-stream.com](mailto:info@aero-stream.com)

## **Critical Safety Warning:**

Always securely attach Cover to Riser by installing and tightening the (4) screws using the appropriate driver tool. Cover must be checked after each tank servicing. Cover must be inspected regularly for damage and security. The secondary safety barrier must be securely fastened in place at all times. The safety barrier must only be removed to gain entry into the tank by a properly credentialed professional donning appropriate safety gear.

## **Tools Required:**

- Safety Gloves/Glasses
- Utility Knife
- #3 Phillips head driver bit
- 5/32" drill bit (carbide tip if septic tank is concrete)

**IMPORTANT!** Use sanitary gloves when working with septic system components, installing equipment into the septic system or handling any equipment that has come into contact with septic effluent. Wear protective eye gear at all times during the installation process.

**CAUTION: INSTALLER AND SERVICE PERSONNEL MUST PLACE THIS GUIDE IN PLASTIC POUCH AND ENSURE IT IS ATTACHED TO THE SAFETY BARRIER AFTER INSTALLATION IS COMPLETE**

## **Installation Video:**

An installation video overviewing the assembly of our kits can be viewed at [www.Aero-Stream.com](http://www.Aero-Stream.com). This video is only a high-level description on how the riser is to be installed. Please always follow the illustrated installation guide that is shipped with the product for specific instructions regarding the assembly process.

**Overview of Aero-Stream® Septic Tank Riser Kit**

**Figure 1** illustrates typical construction of septic tank riser kits 7" – 19" tall.

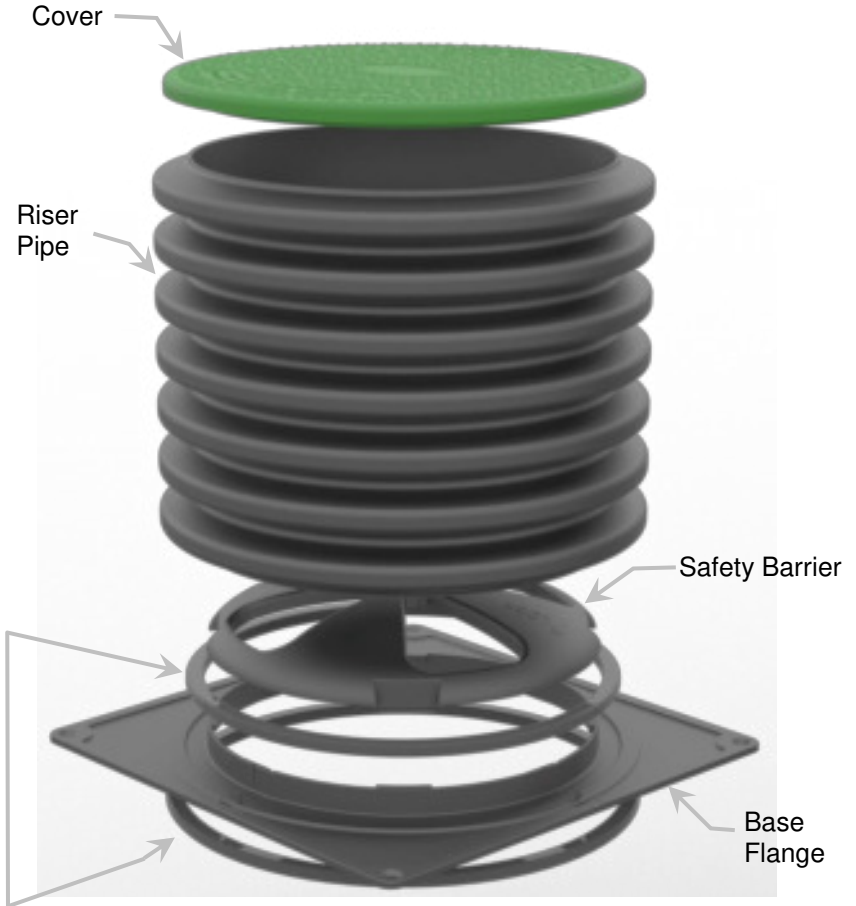

Butyl Rope in Top Groove and Bottom of Flange All-Around 160" (83" Bottom + 77" Top)

**Figure 2** illustrates typical construction of septic tank riser kits 23" – 38" tall.

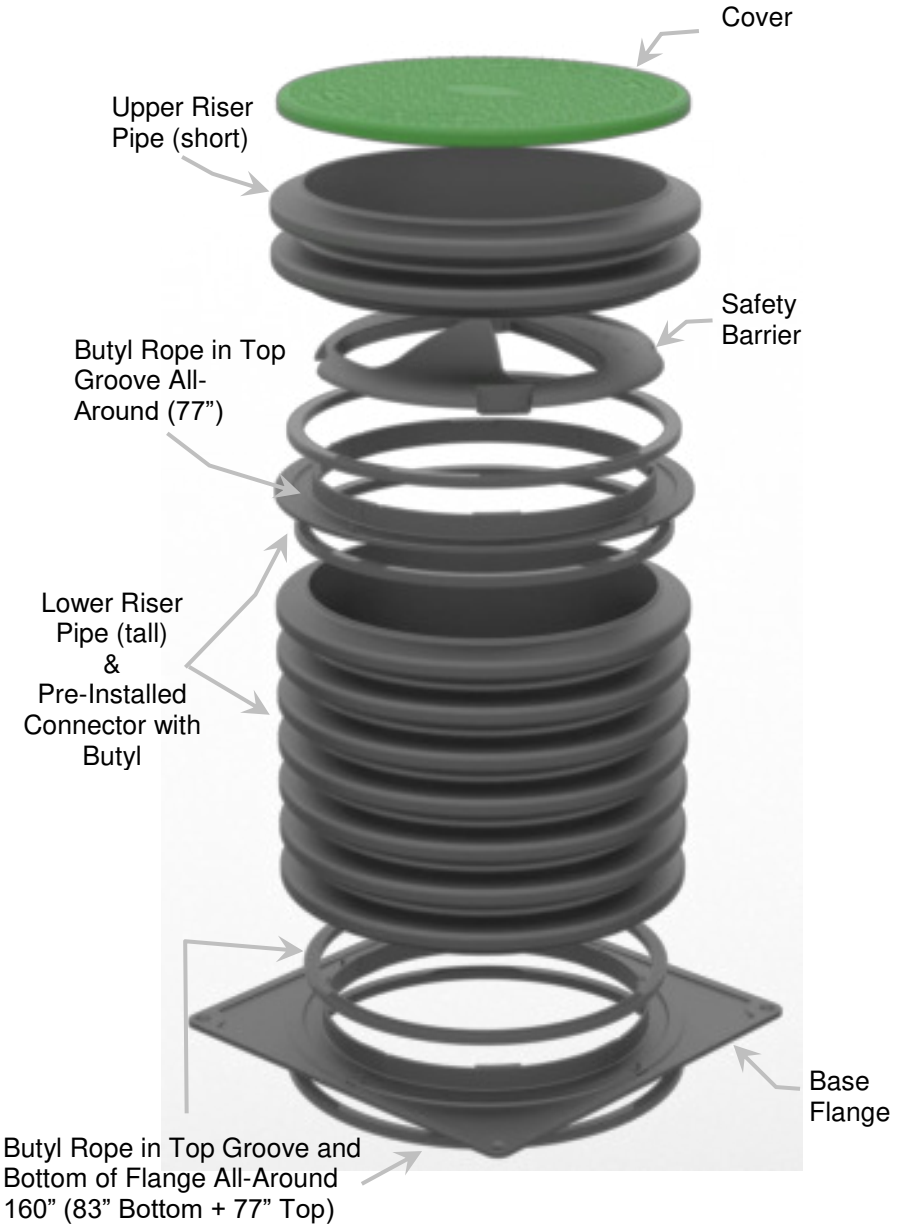

**Figure 3** illustrates typical construction of septic tank riser kits 41" – 50" tall.

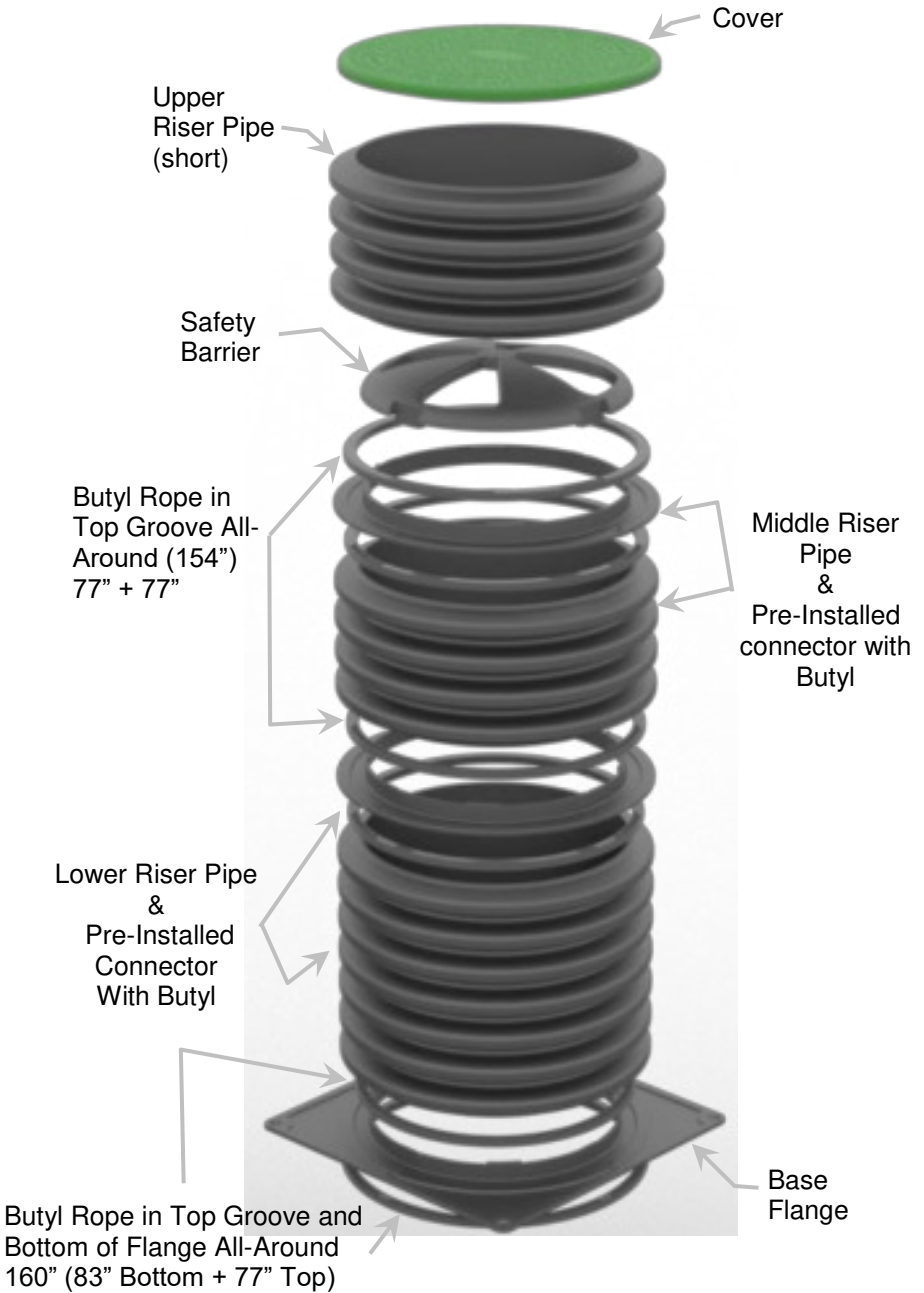

**The Installation Process:**

*Installation must be performed by person possessing mechanical competence.*

- 1.) Assemble riser flange by interlocking the four sections as shown in Fig. 4 below:

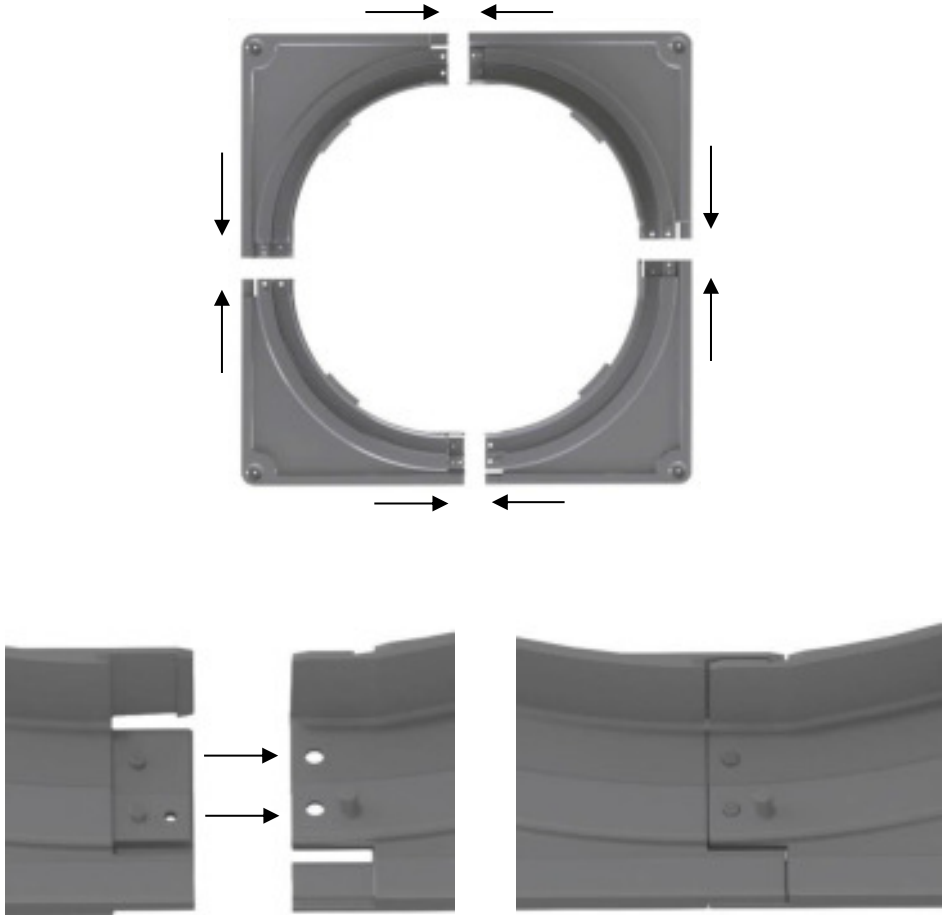

Figure 4: Assembly of base flange

- 2.) With the white tape upward, apply approximately 77” of butyl sealant rope around the perimeter of the adapter flange where the riser pipe will meet the flange (Fig.5). Cut off remaining butyl sealant & set aside for further steps. Overlap and knead the ends of the butyl rope together to ensure a water-tight seal.

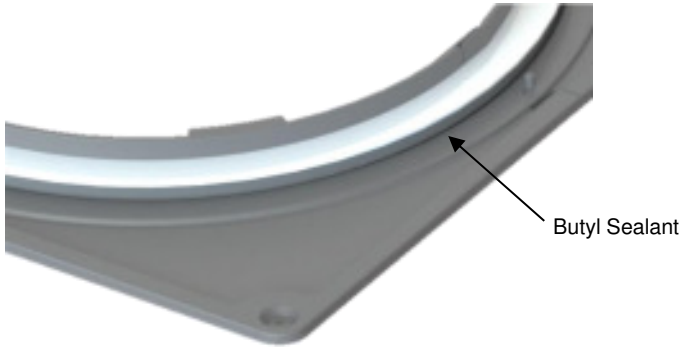

Figure 5

- 3.) Remove the white tape from the sealant rope and discard the tape.
- 4.) Center the riser pipe on the adapter flange so the gap is even all of the way around. Do not apply downward pressure while adjusting the gap. When the even gap is achieved, lightly lower the riser pipe onto the butyl rope. As required, make final adjustment and apply firm downward pressure to seat the riser pipe into the butyl rope. Apply the pressure all around the riser pipe every 30 degrees.
- 5.) Locate the four (4) mounting dimples on the inside perimeter of the adapter flange (Fig.6).

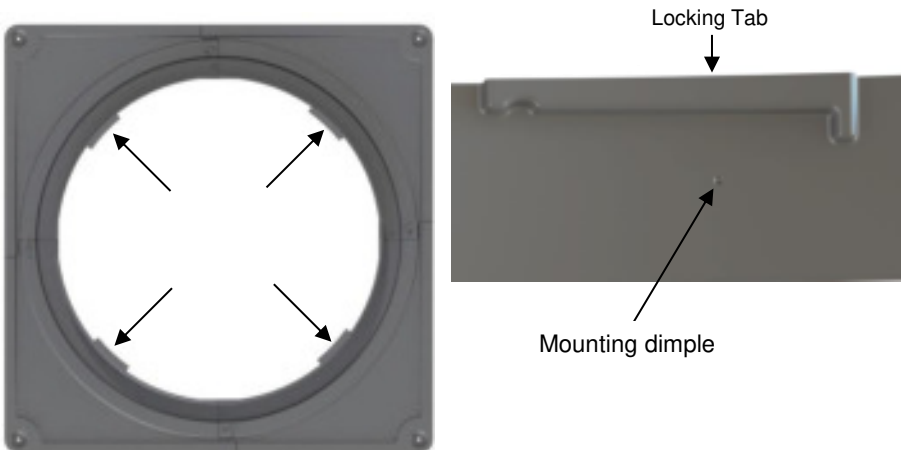

Figure 6: Locate four mounting dimples

- 6.) Install four (4) screws into mounting dimples to attach the adapter flange to the riser pipe. Drive the screws until the head makes contact with the adapter flange & slightly compresses the flange (Fig 7.) & (Fig 8). There should be a visible gap (1/2") between base flange & pipe once installed.

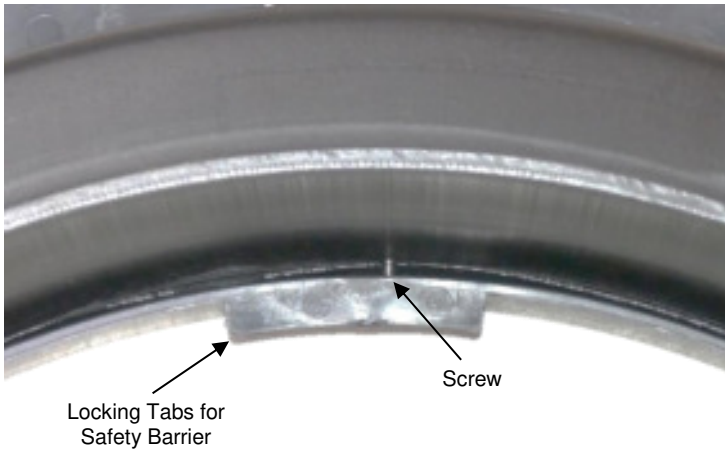

Figure 7: Screw installed (Top down view)

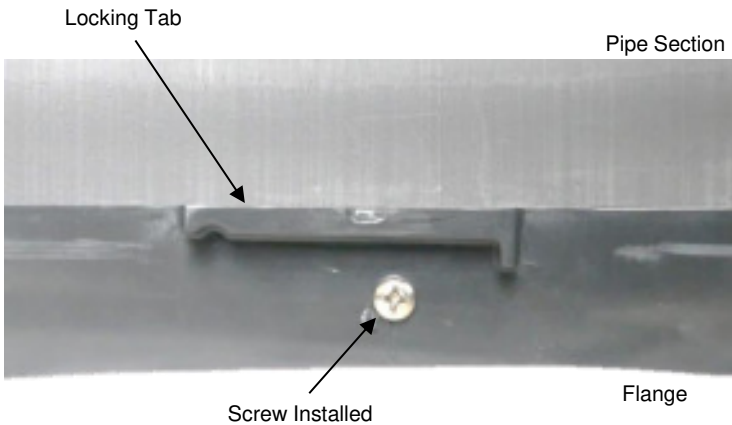

Figure 8: Screw installed (Side view)

**Repeat steps 2 – 6 for each section for risers 23" tall and greater.**



## **How to Install the Safety Barrier:**

- 7.) *Locate the four mounting tabs on the safety barrier (Fig. 9). Insert the safety barrier into the locking tabs on base flange (Fig 8), (Fig. 9) & (Fig. 10).*

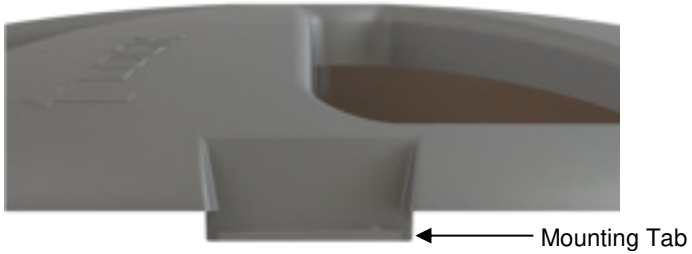

Figure 9

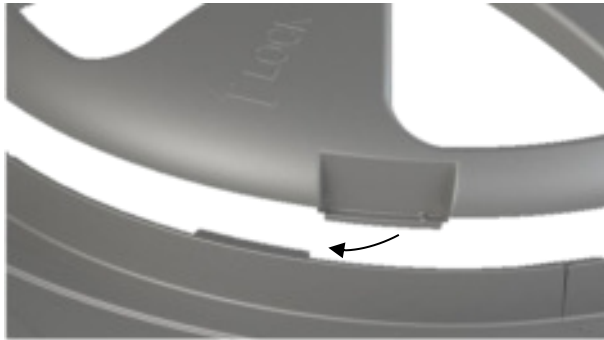

Figure 10: Inserting Safety Barrier

- 8.) *Confirm all four mounting tabs are positioned with all four locking tabs. Rotate the safety barrier clockwise, the direction the "LOCK ARROW" points. A slight rap with the palm of the hands in the safety barrier triangular openings will seat the safety barrier in place.*
- 9.) *Grasp the openings of the safety barrier and pull upward lightly. It must not dislodge from the assembly. If any of the mounting tabs are not engaged with the locking tabs, remove the safety barrier and repeat step 7 through step 9 until the safety barrier is secure.*

**WARNING: FAILURE TO PROPERLY ENGAGE THE SAFETY BARRIER WILL DEFEAT THE SAFETY FEATURE OF THE DEVICE!**

## Mounting the Riser Kit:

- 10.) Expose and clean a 32" x 32" square area on the top of the septic tank centered on the clean-out opening on the tank.



Figure 11

- 11.) With the white tape upward, apply the remaining butyl sealant rope around the groove on the bottom of the adapter flange; overlapping and kneading the ends of the butyl rope together (Fig. 12). Remove the white tape from the sealant rope and discard the tape.

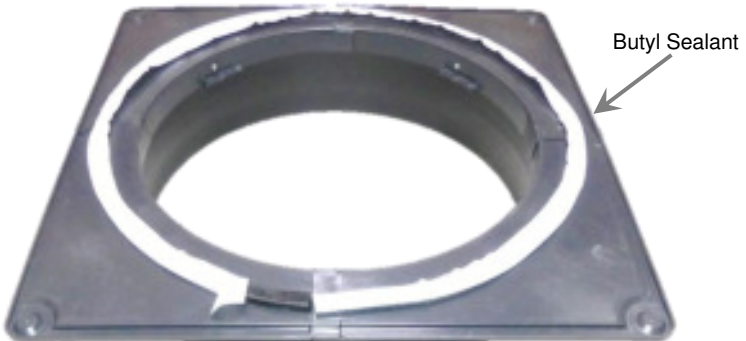

Figure 12

**Due to variations in tank opening sizes, the butyl sealant may need to be stretched and applied elsewhere on the underside of the base flange to provide water tight seal**

- 12.) Center the riser assembly on the tank clean-out opening and apply pressure around the perimeter of the base flange above the butyl sealant rope to compress sealant between the tank and the adapter flange.

13.) Drill (4) 5/32" diameter holes through the four corners of the adapter flange (Fig. 13) at least 2" deep into the tank. If the tank is made of concrete, use a carbide tip masonry bit.

**Warning: Ensure holes are free of debris otherwise fastener failure may occur**

14.) Fasten the base plate to the tank using four (4) enclosed blue Tapcon screws (Fig 13).

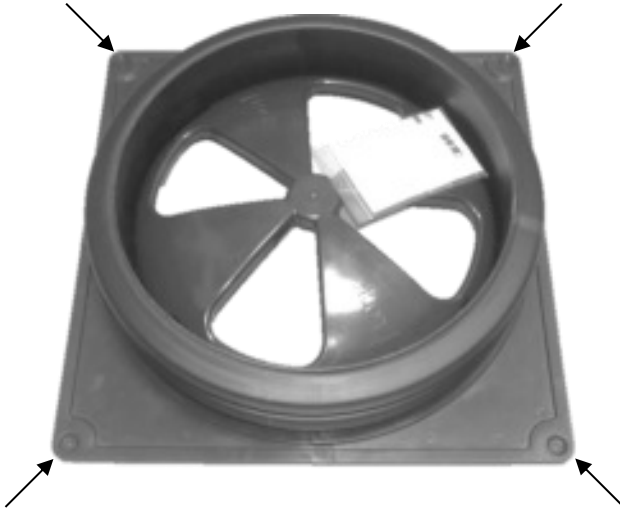

Figure 13: Mounting Base Flange

15.) Backfill around riser with sand or washed stone to prevent movement from frost if applicable in your climate.

16.) **Always re-install (4) cover security screws and tighten (2 in-lbs.) with appropriate driver tool to secure riser cover to riser pipe (Fig.14)**

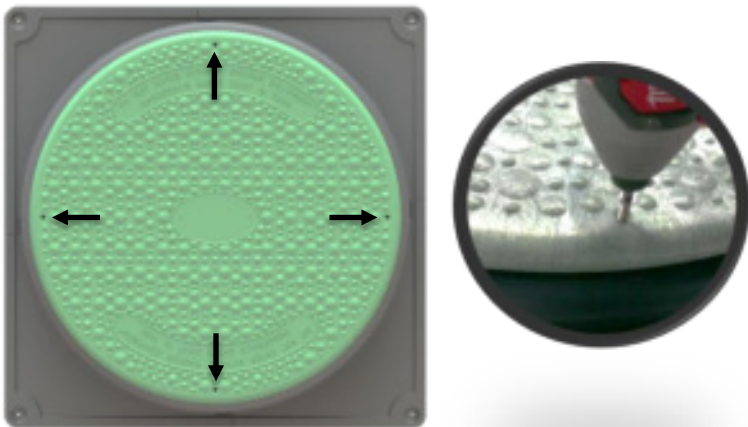

Figure 14: Cover installed